

HONDA



Artwork by Yasu Tanaka
Copyright ©

SuTanaka
<http://www.ne.jp/asahi/paper-m/yasu/>

● Parts List

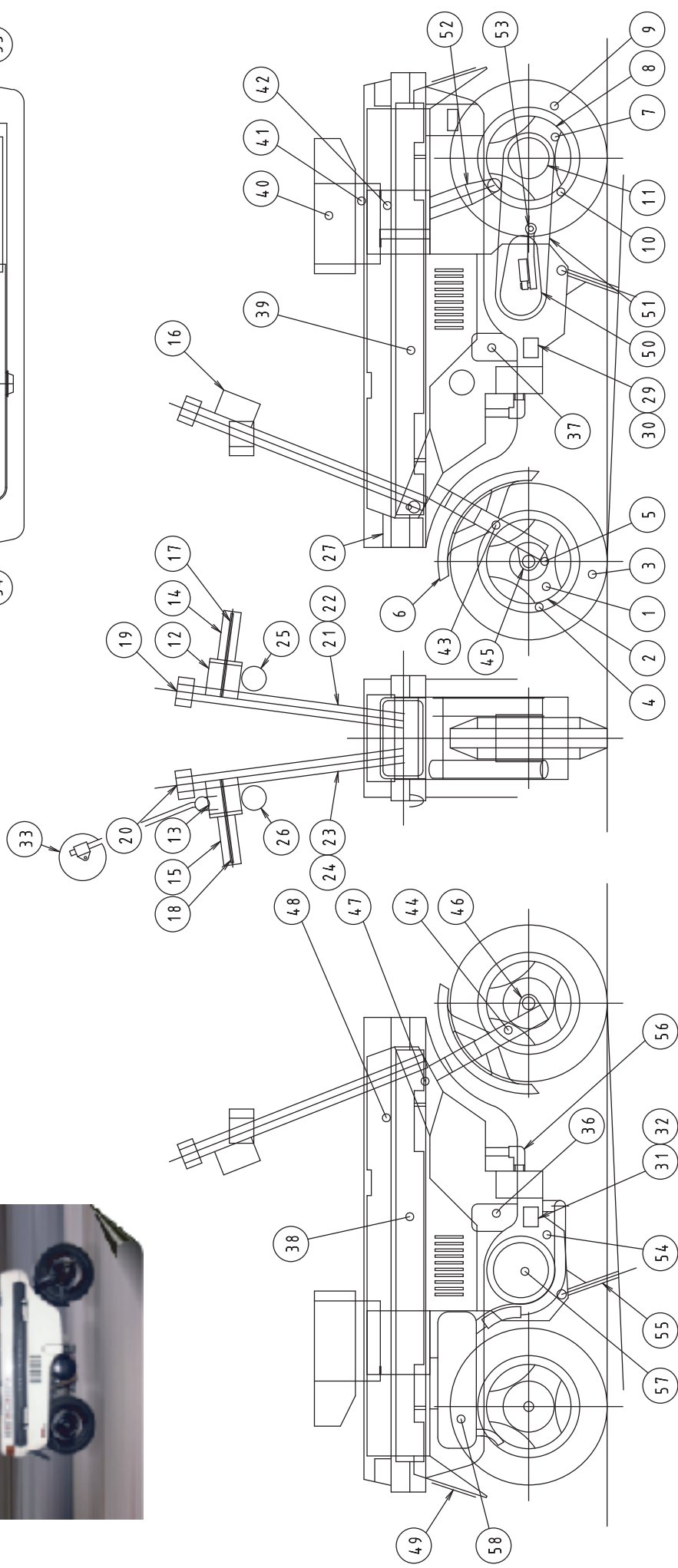
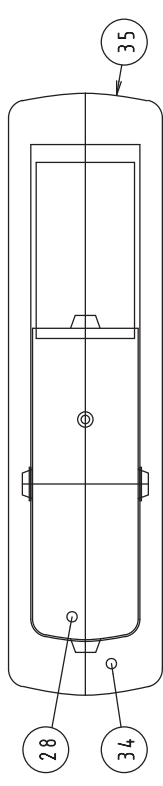

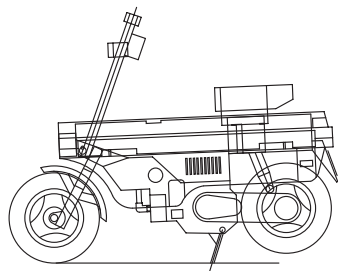
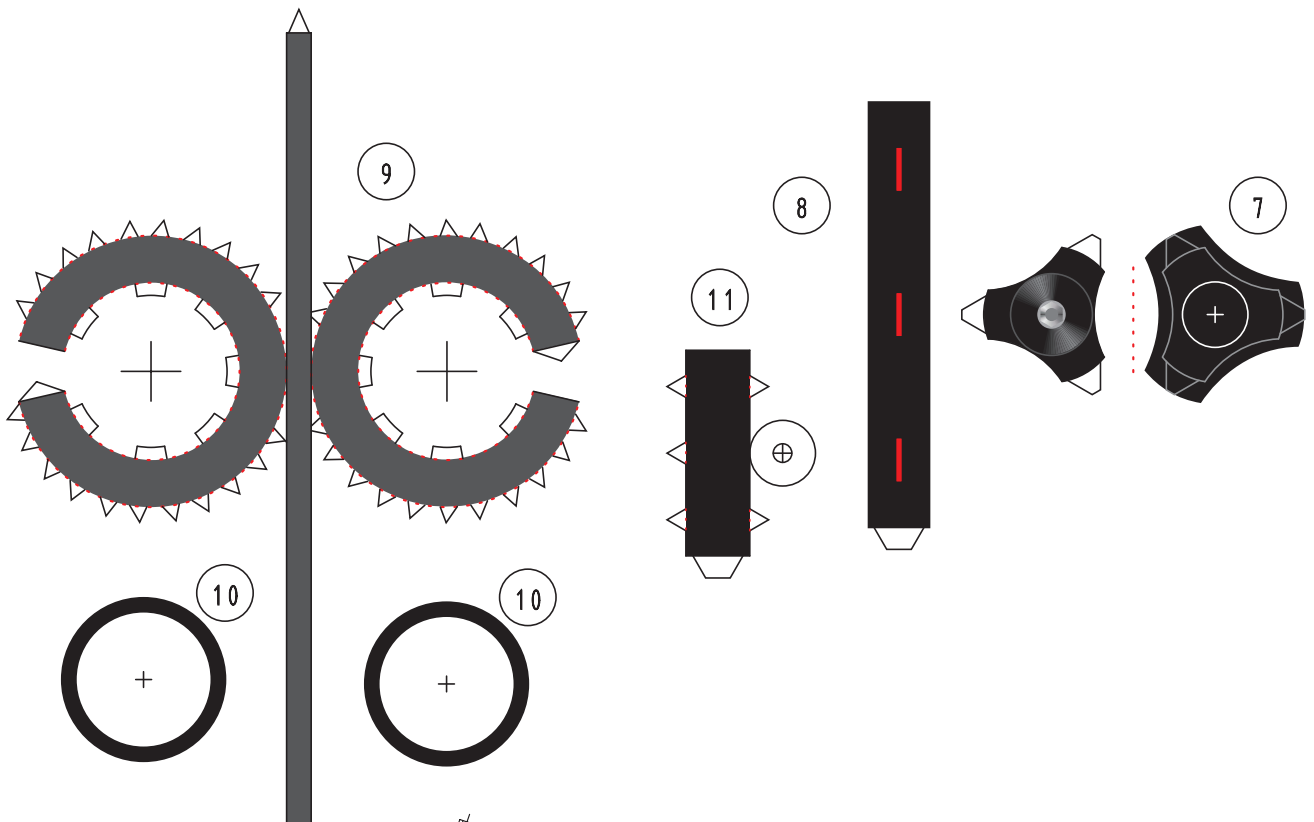
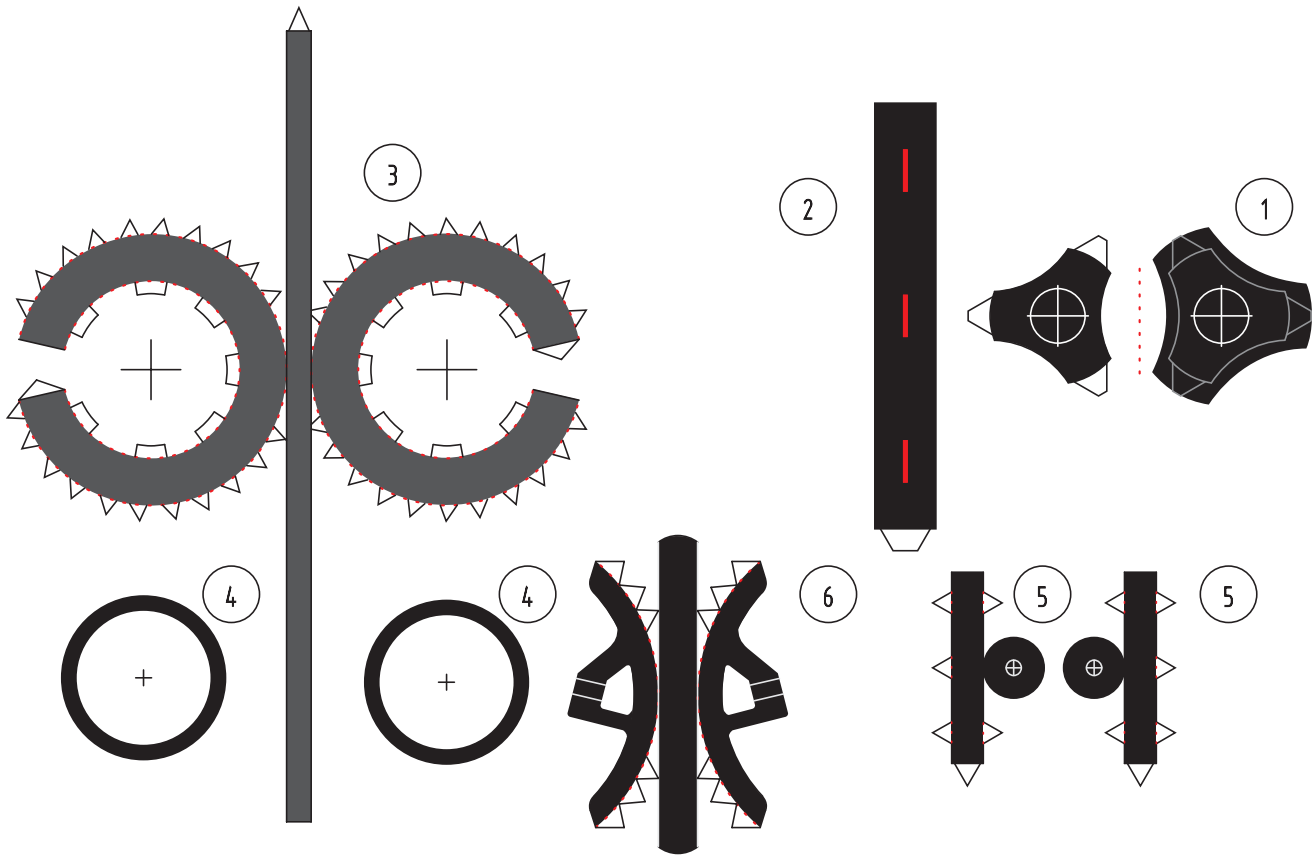

HONDA

MOTORCYCLES

Artwork by Yasu Tanaka
Copyright ©
Yasu Tanaka
<http://www.ne.jp/asahi/paper-m/yasu/>

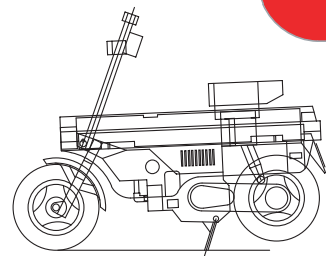
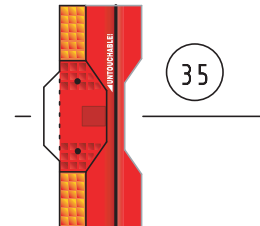
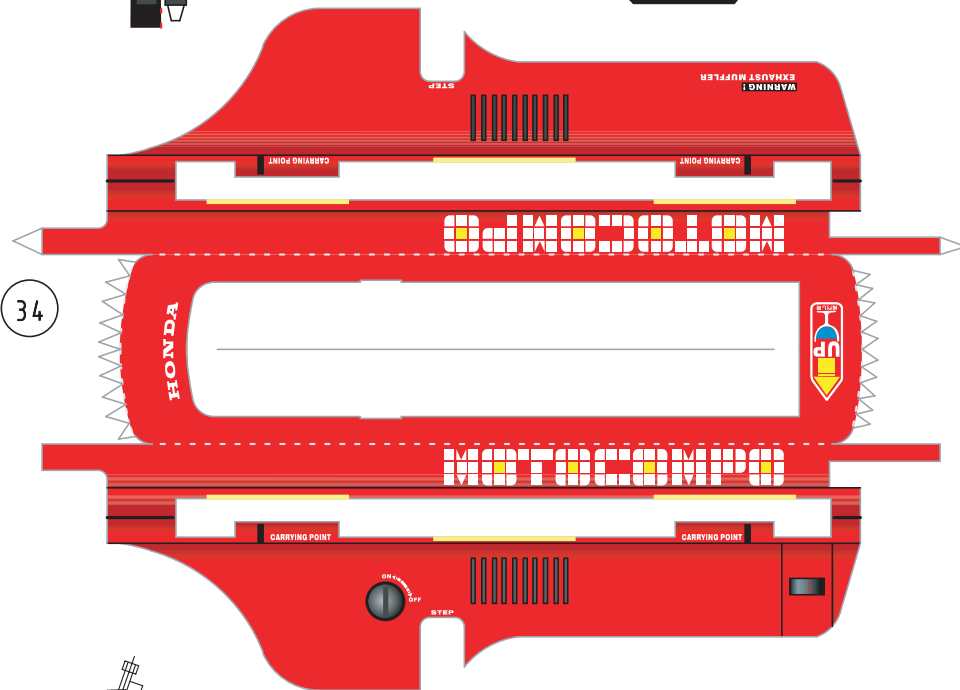
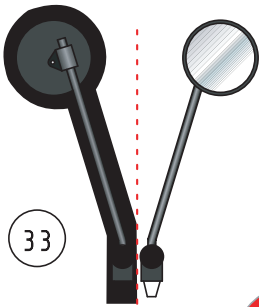
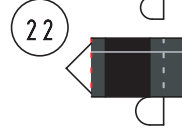
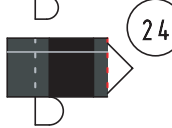
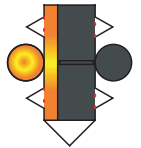
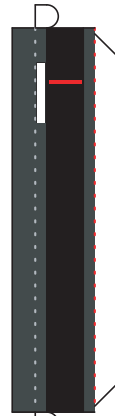
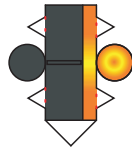
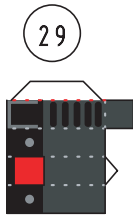
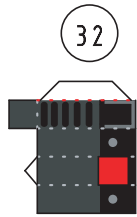
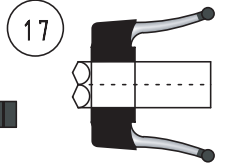
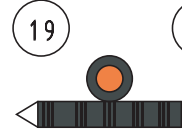
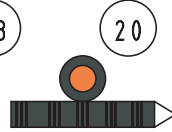
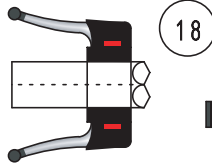
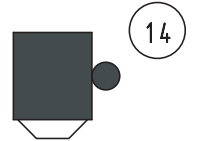
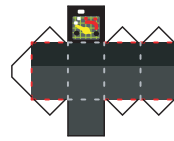
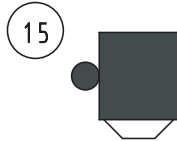
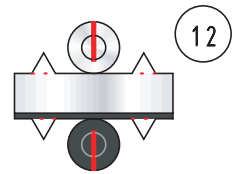
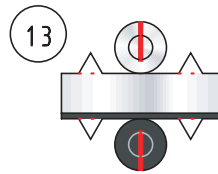
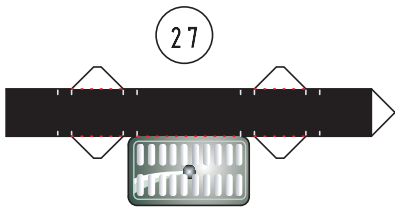

HONDA

MOTORCYCLE

Artwork by Yasu Tanaka
Copyright ©
Yasu Tanaka
<http://www.ne.jp/asahi/paper-m/yasu/>

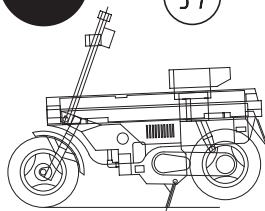
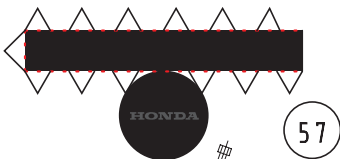
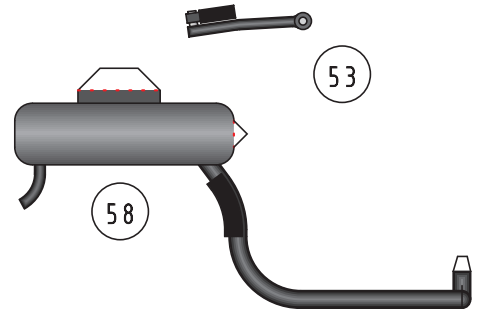
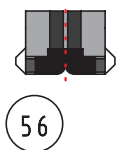
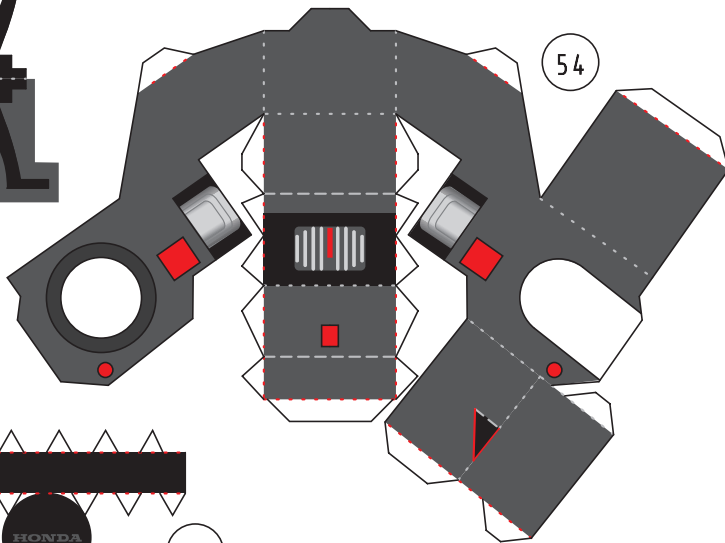
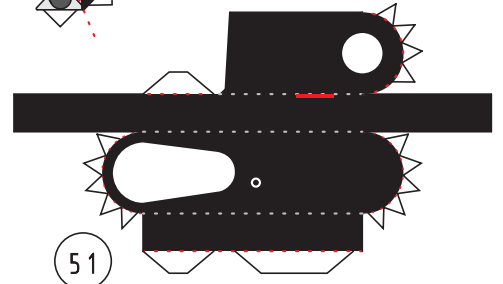
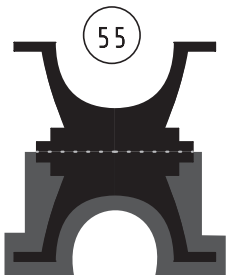
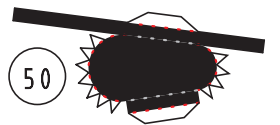
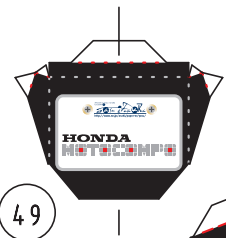
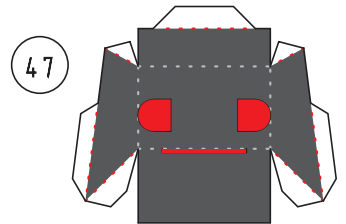
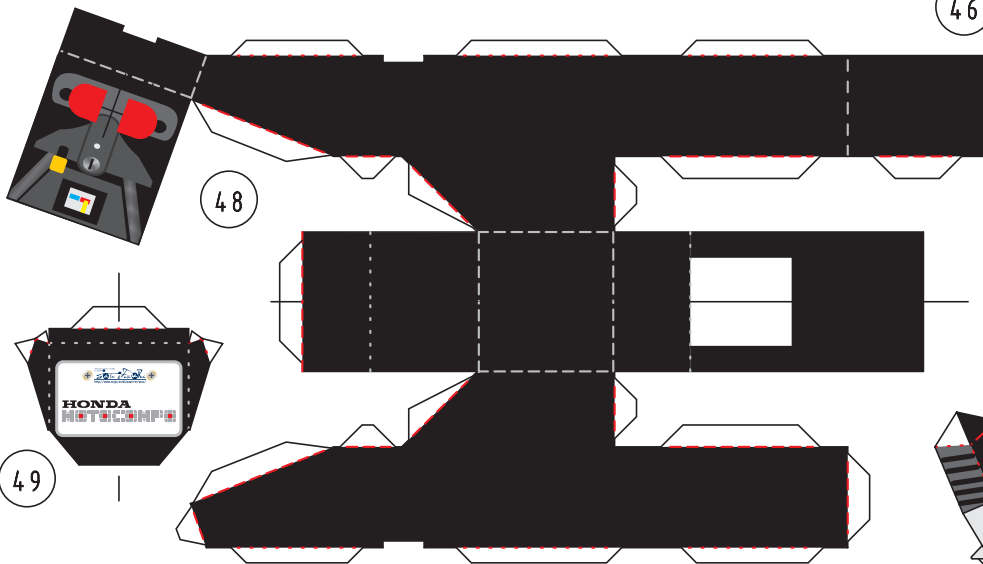
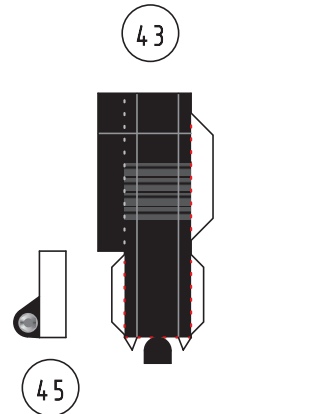
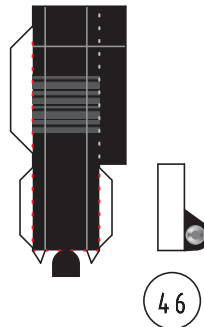
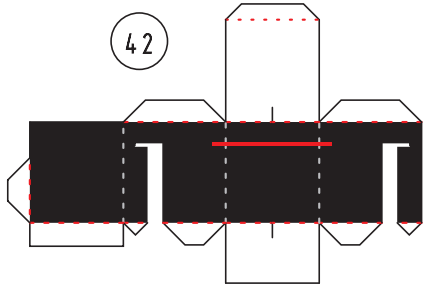
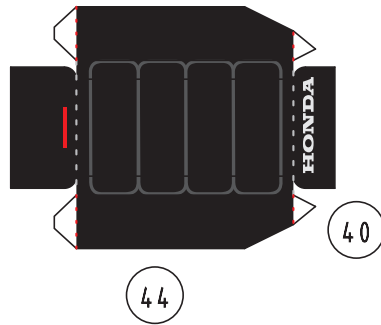
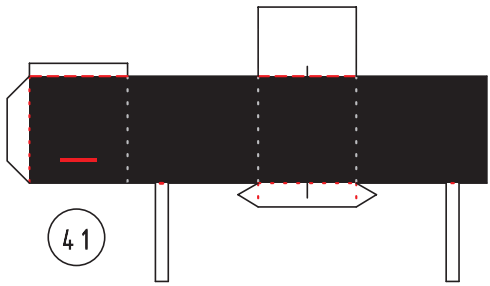

HONDA

MOTORCYCLE

Artwork by Yasu Tanaka
Copyright ©
SaSu Tanaka
<http://www.ne.jp/asahi/paper-m/yasu/>