

# HONDA



Artwork by Yasu Tanaka  
Copyright ©

**SAsuTanaka**  
<http://www.ne.jp/asahi/paper-m/yasu/>

## ● Parts List

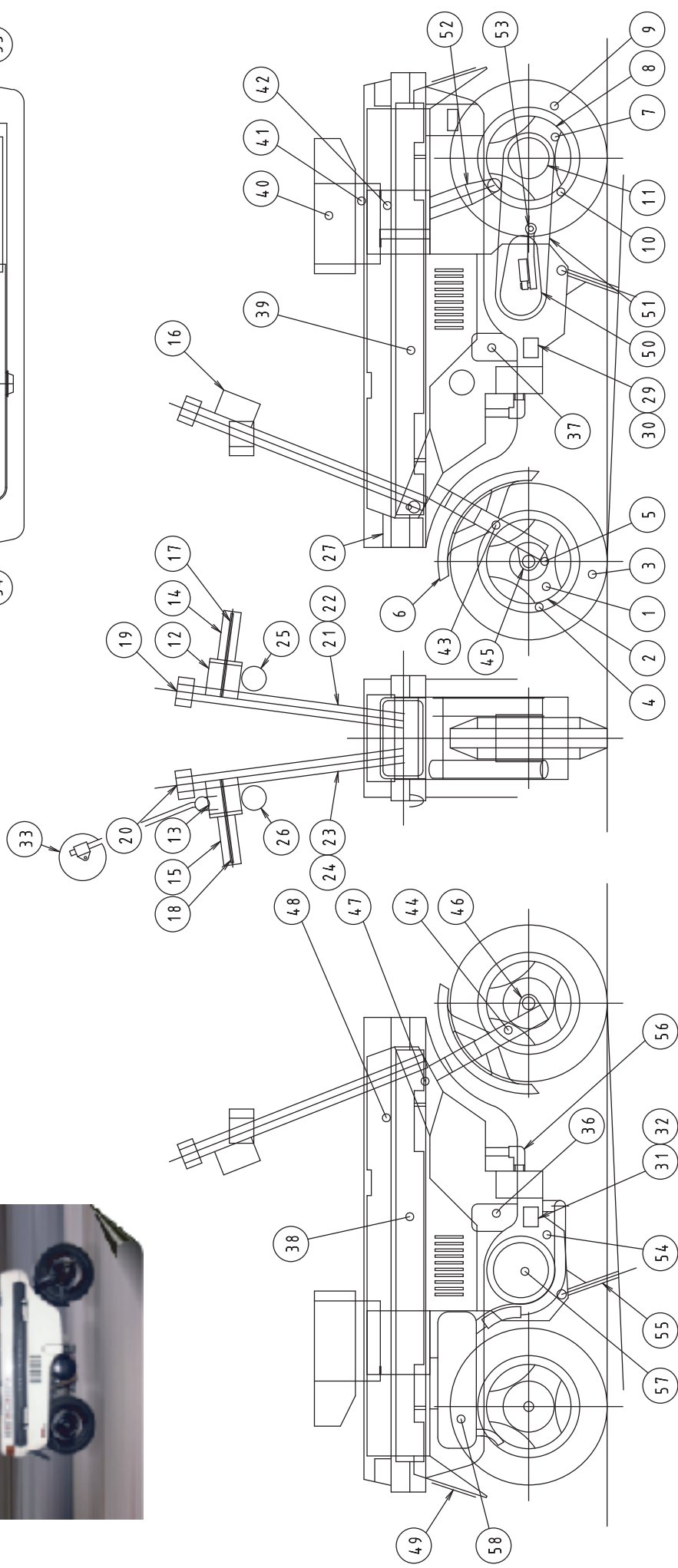
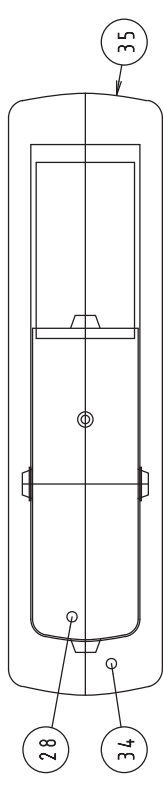

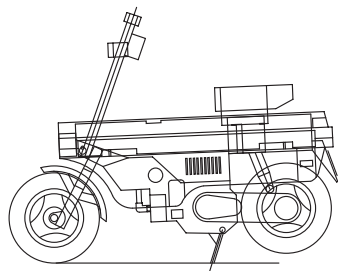
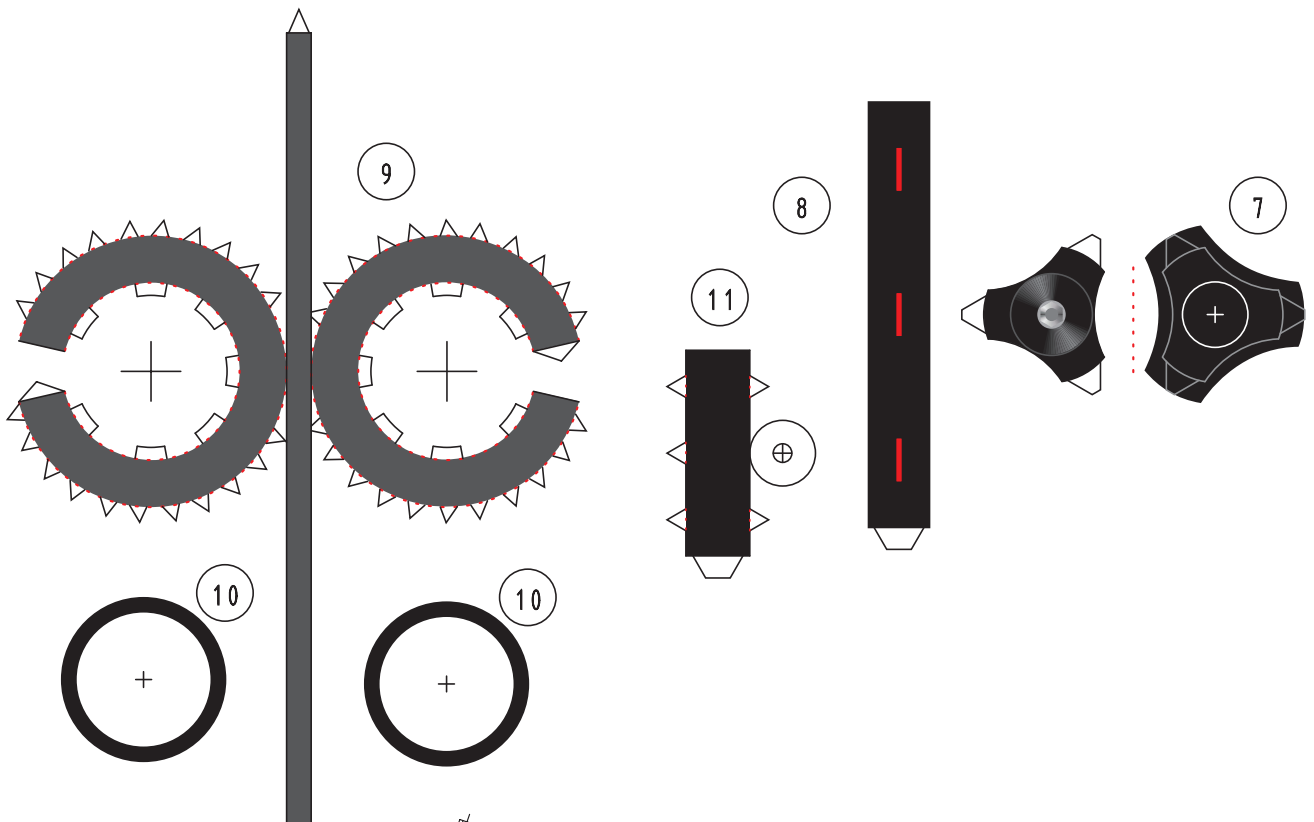
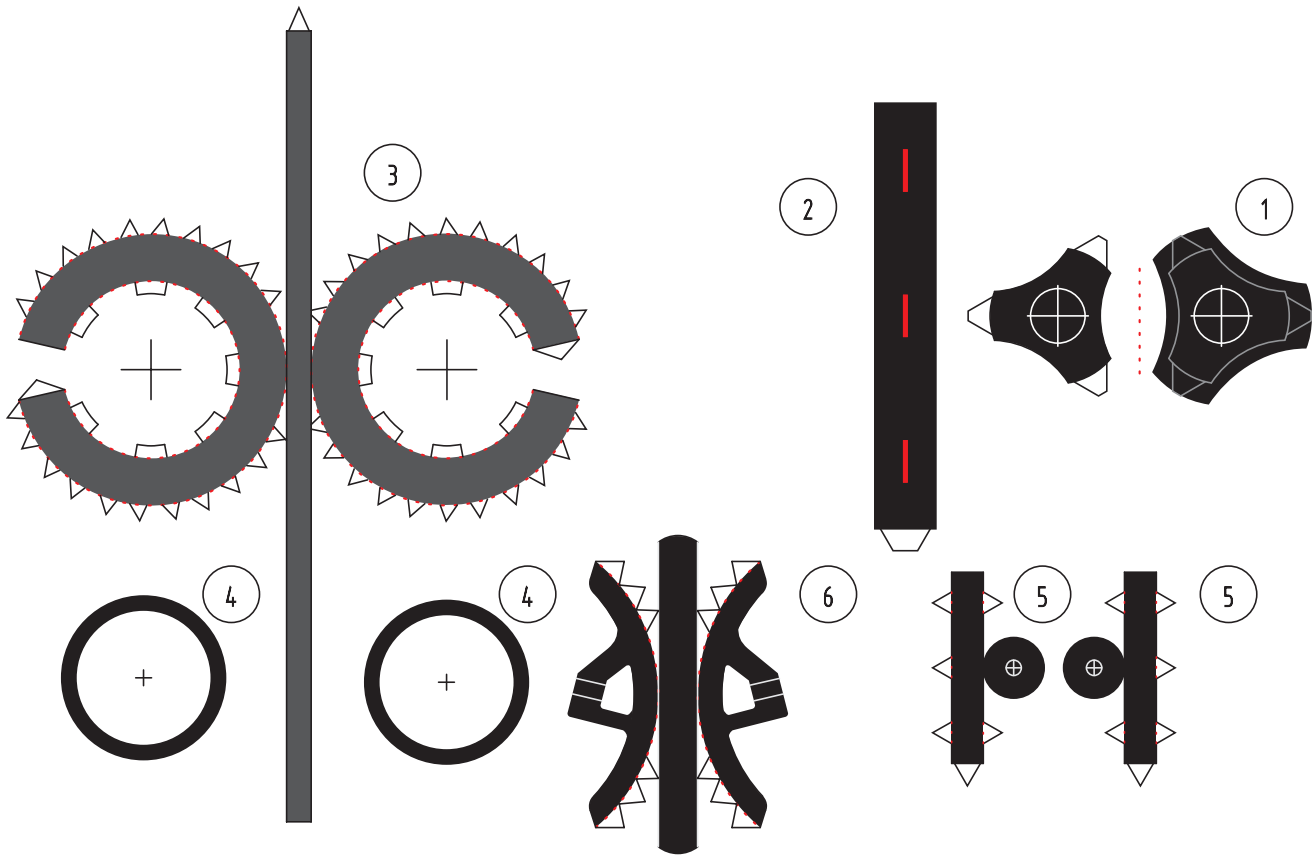

**HONDA**

MOTORCYCLES

Artwork by Yasu Tanaka  
Copyright ©  
*Yasu Tanaka*  
<http://www.ne.jp/asahi/paper-m/yasu/>

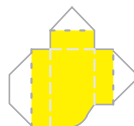
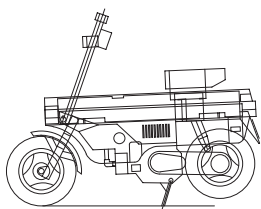
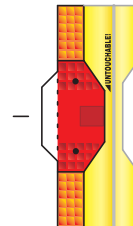
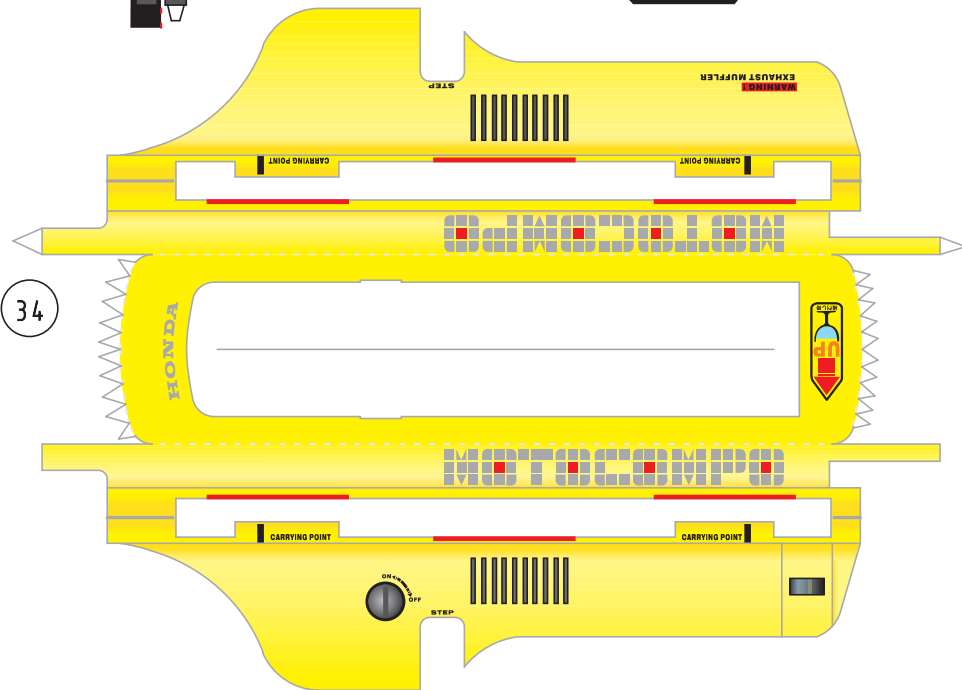
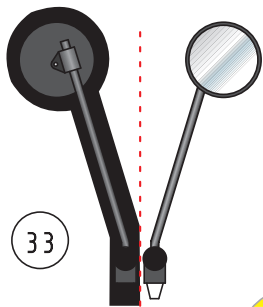
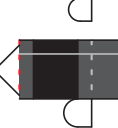
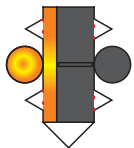
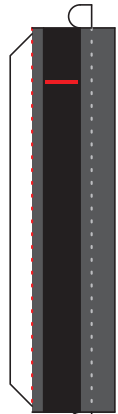
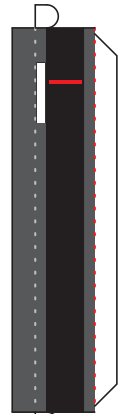
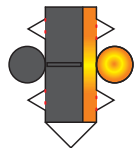
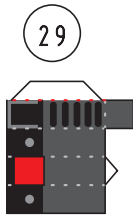
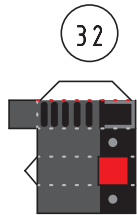
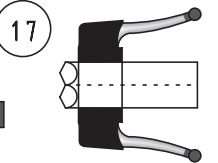
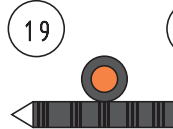
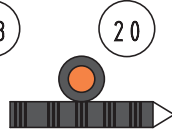
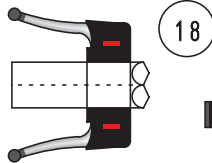
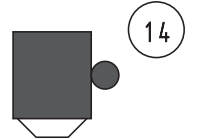
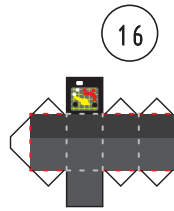
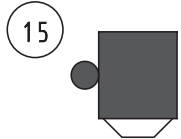
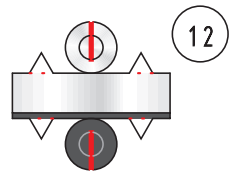
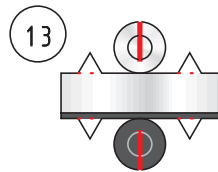
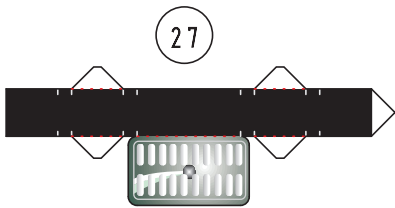

**HONDA**

**MOTORCOMP**

Artwork by Yasu Tanaka  
Copyright ©  
*Yasu Tanaka*  
<http://www.ne.jp/asahi/paper-m/yasu/>

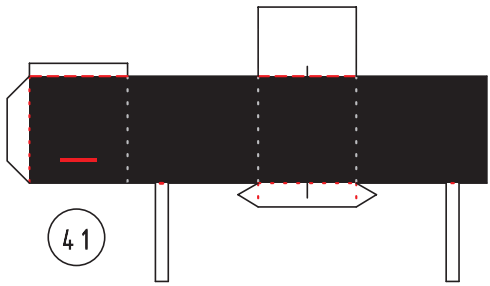

41

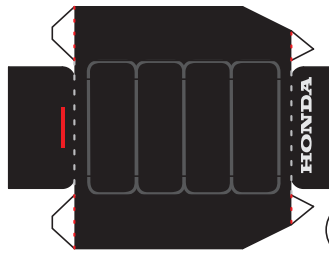

40

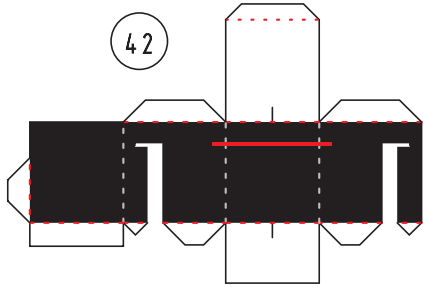

42

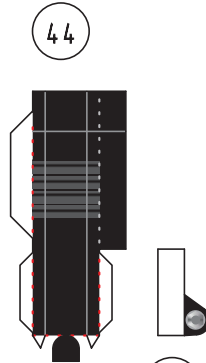

44

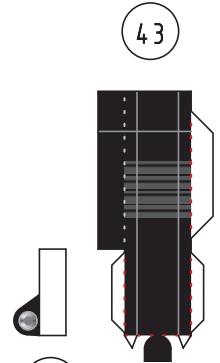

43

46

45



48

47

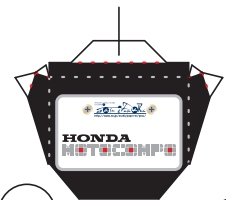

49



52

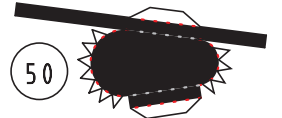

50



51

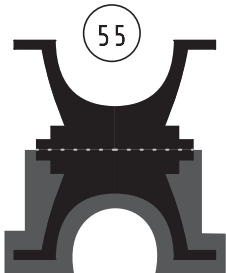

55

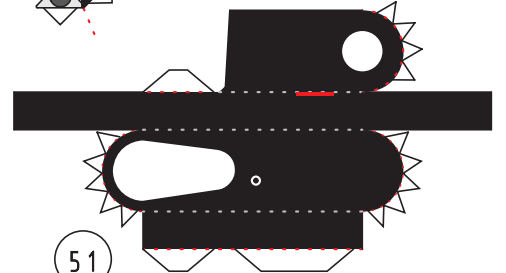

54



56

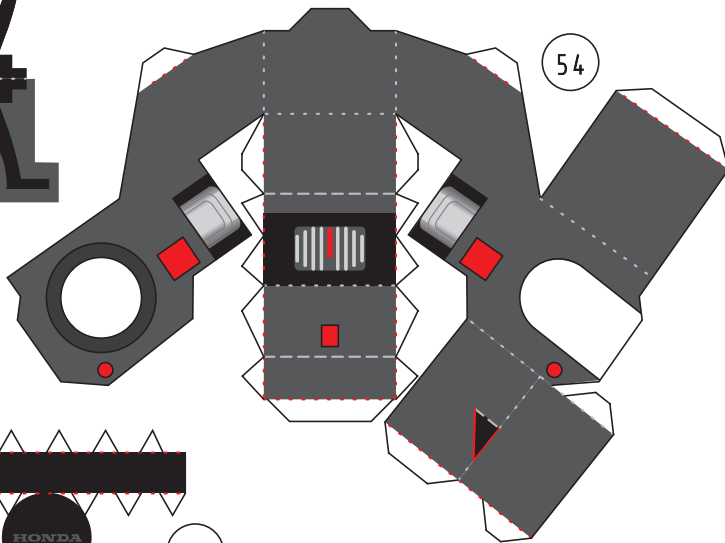

57



53

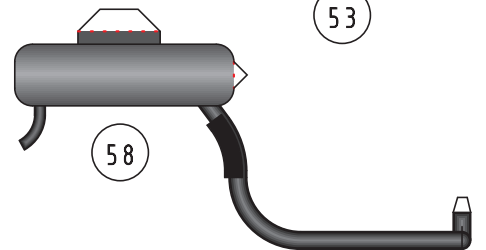

58



HONDA

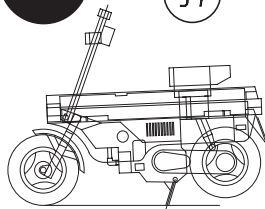

# HONDA

# MOTOCOMP

Artwork by Yasu Tanaka  
Copyright ©

*Yasu Tanaka*  
<http://www.ne.jp/asahi/paper-m/yasu/>